



BARDAKLAR

GROUP

DIŐ CEPHE YALITIM SİSTEMLERİ



2026 ÜRÜN KATALOĐU

www.bardaklargroup.com



KALİTE POLİTİKAMIZ

Yapıların karakterini ve prestijini belirleyen en güçlü unsur, dışa vurumları olan cepheleridir. Bizler, mimari tasarım süreçlerindeki derin tecrübemizi üretim hassasiyetiyle birleştirerek, projelere yalnızca bir dekorasyon malzemesi değil; estetik, katma değer ve yıllara meydan okuyan bir kimlik kazandırmayı hedefliyoruz.

Kalite anlayışımızın temelinde, mimari vizyonu şantiyedeki gerçeklikle buluşturmak yatmaktadır. Bilgisayar ortamında üç boyutlu olarak milimetrik hassasiyetle modellediğimiz her bir formun; dijital boyuttan üretim hattına ve nihayetinde yapının dış cephesine başarıyla işlenmesine kadar olan tüm aşamalarında aynı titizliği koruyoruz. Ekranda tasarlanana sahada eksiksiz hayat bulması için; yapı fiziğine tam uyum, iklimsel şartlara karşı yüksek direnç ve montajı mükemmelleştiren kusursuz yüzey kalitesi vazgeçilmez standartlarımızdır.



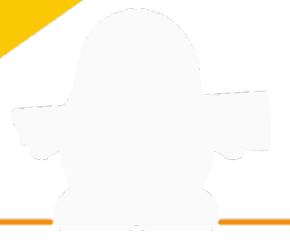

İÇİNDEKİLER

Cephe kaplamaları	04
Söveler	08
Denizlikler	13
Taçlar	15
Boru kapamalar	17
Köőe Elemanları / Corner Elements	18
Harpuşta / Capsnes	19
Payanda / Buttres	20
Sütun ve Kaideler / Pillar & Pedestals	21
Dekoratif Profil/ Decorative Profile	21
Dekoratif Ürünler / Decorative Products	22
Kilit Taşı / Key Stone	27



CEPHE KAPLAMALARI

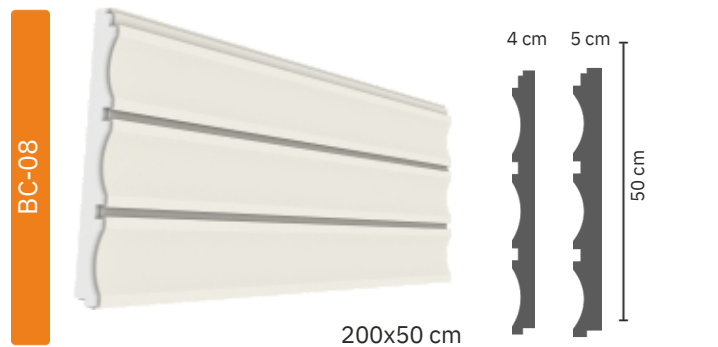
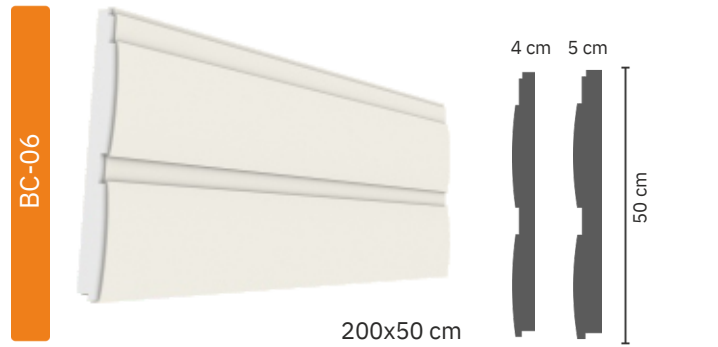
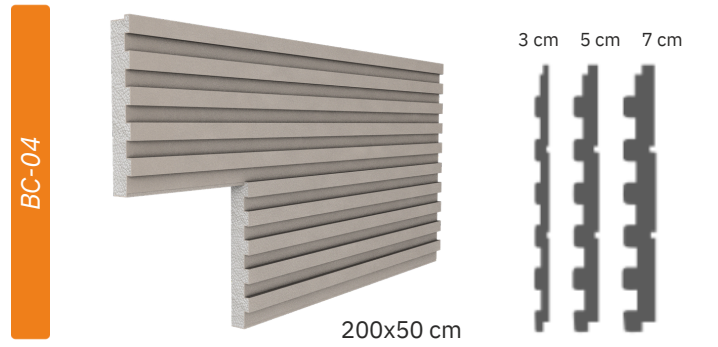
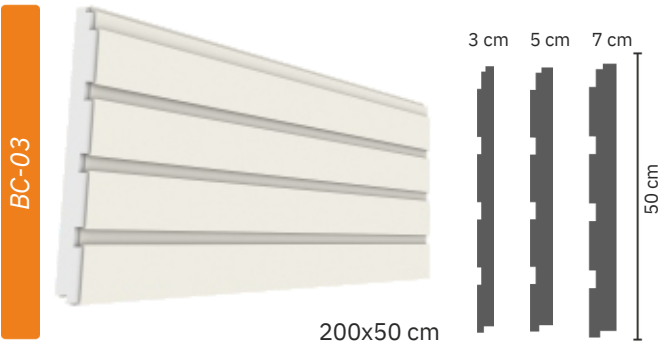
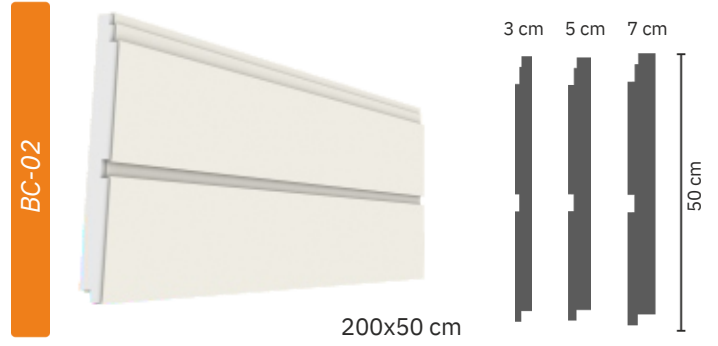
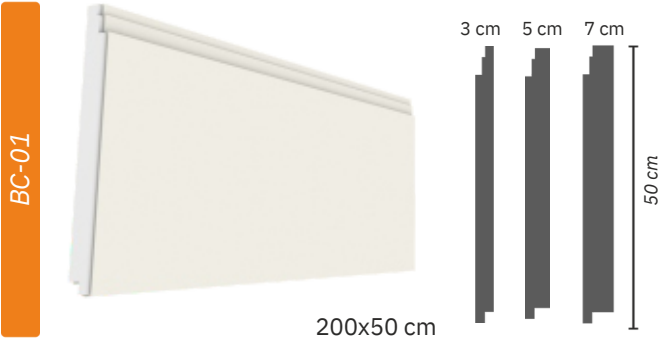

BC-09

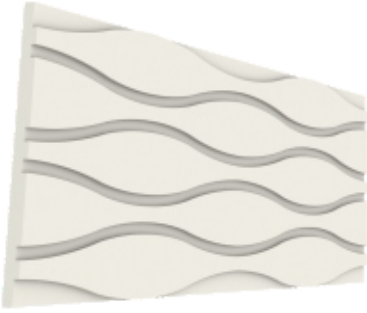

100x50 cm

3 cm 4 cm 5 cm

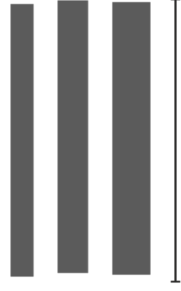

BC-10



200x50 cm

4 cm 5 cm

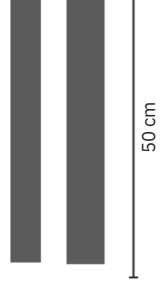

BC-11



200x50 cm

4 cm 5 cm

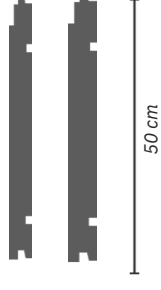

BC-12



200x50 cm

4 cm 5 cm

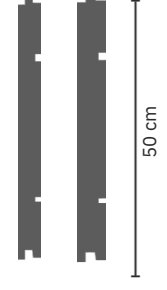

BC-13

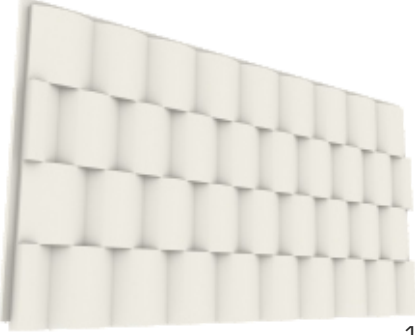

100x50 cm

4 cm 5 cm



BC-14



200x50 cm

3 cm 4 cm 5 cm

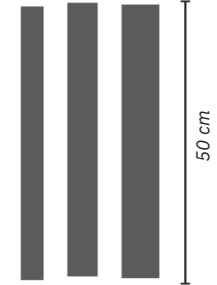

BC-15

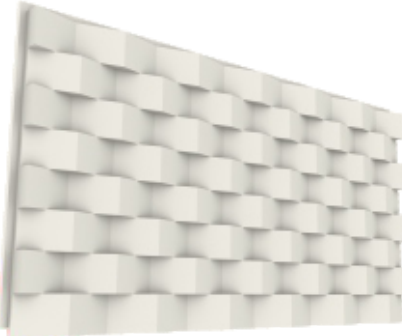

120x50 cm

4 cm



BC-16



200x50 cm

3 cm 4 cm 5 cm

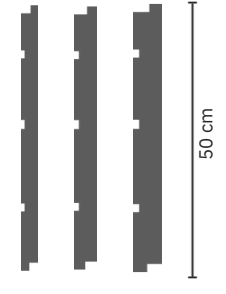



YALITIMLI DEKORATİF İÇ VE DIŐ CEPHE ÜRÜNLERİ



YAPINIZA YÜK BİNDİRMEZ
DEĞER KATAR...

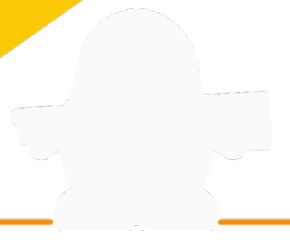

1 Bir kova ierisine DiŐ Cephe YapıŐtırma Harcı ve su konarak mikser yardımı ile karıŐtırılır.



2 Uygulama yapılacak alanın ölçüsü alınır. Alınan ölçüye göre fuga kesilir.



3



Malzemenin yapıŐtırılacak yüzeyine yapıŐtırma harcı sürülür ve uygulama yüzeyine yapıŐtırılır.

4



Yüzeyin uygulamaya uygun olmasına dikkat edilir. YapıŐtırma harcı uygulanmış fuga uygulama yüzeyine yapıŐtırılır.

5



Fuga uygulama yüzeyine sağa sola titreterek yapıŐtırılır ve teraziye alınır.

6



ŐaŐırtma yöntemi ile üst plaka ve alt plaka birleŐtirilir ve yüzey düzgünleŐtirilir. RütüŐ işlemleri yapılır.

7

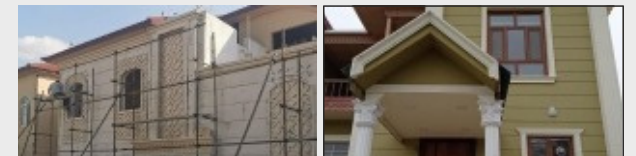

RütüŐ işlemlerinin sonunda dekoratif sıva işlemi ve boya işlemi yapılarak uygulama tamamlanır

BSV-01

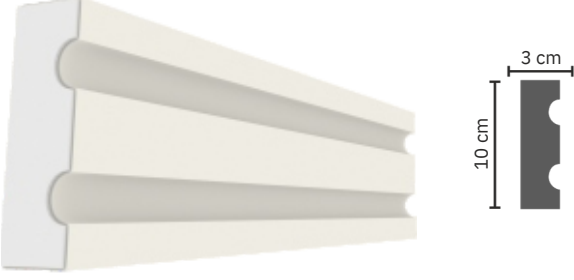

BSV-02



BSV-03



BSV-04

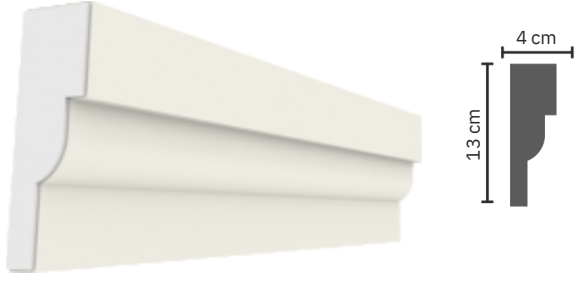

BSV-05



BSV-06



BSV-07



BSV-08



BSV-09

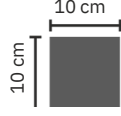

BSV-10

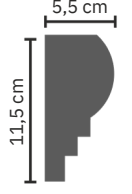

BSV-11

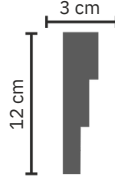

BSV-12

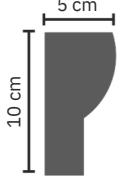
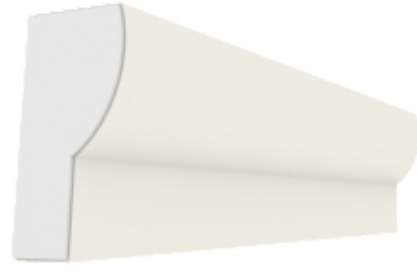

BSV-13



BSV-14

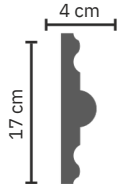

BSV-15

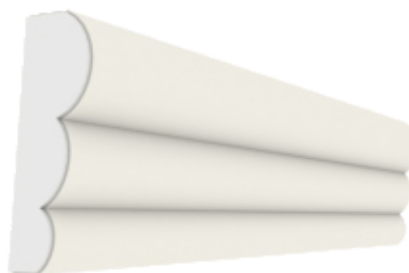

BSV-16

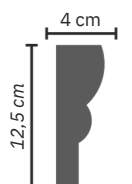
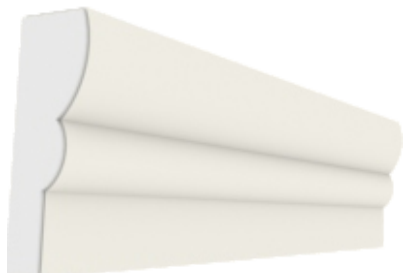



SÖVELER

BSV-17



BSV-18



BSV-19



BSV-20



BSV-21

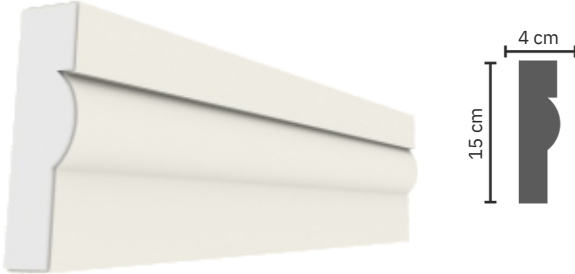

BSV-22



BSV-23



BSV-24





BSV-25



BSV-26

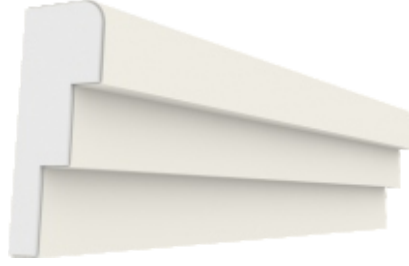

BSV-27

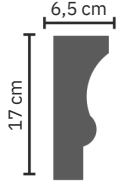

BSV-28

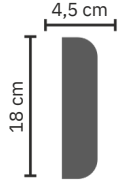

BSV-29

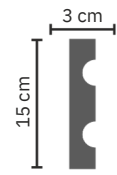
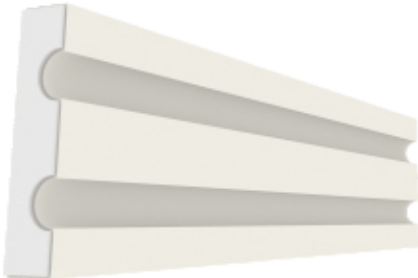

BSV-30

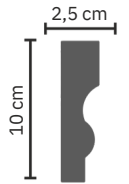
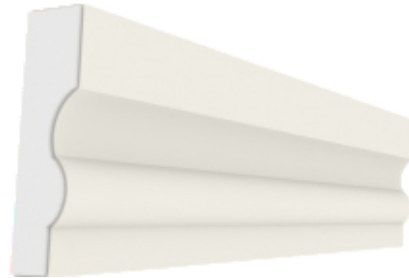

BSV-31

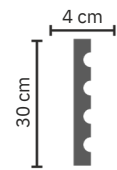
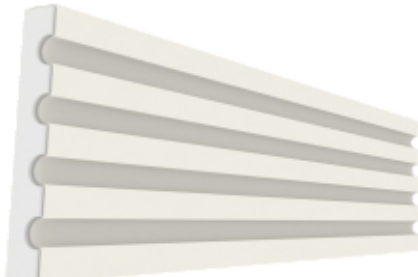

BSV-32

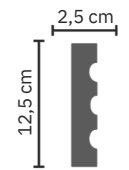



TAŐ YÜNÜ SÖVELER / ROCK WOOL JAMP



AYT-01

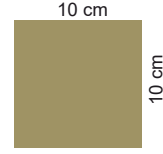

AYT-02



AYT-03

AHŐAP SÖVE / WOOD JAMP

AHŐAP-01

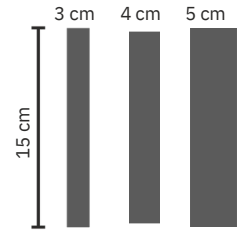
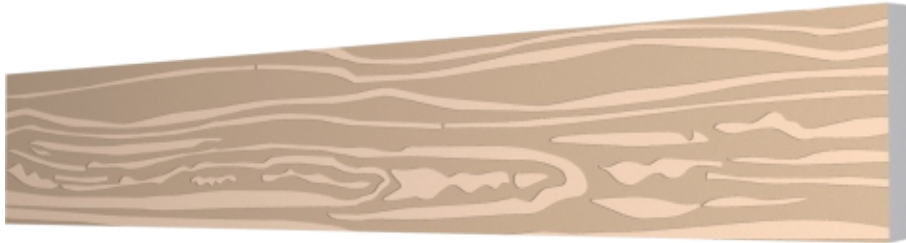

AHŐAP-02

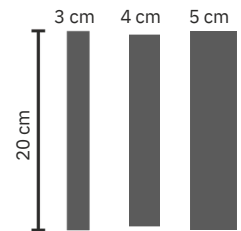
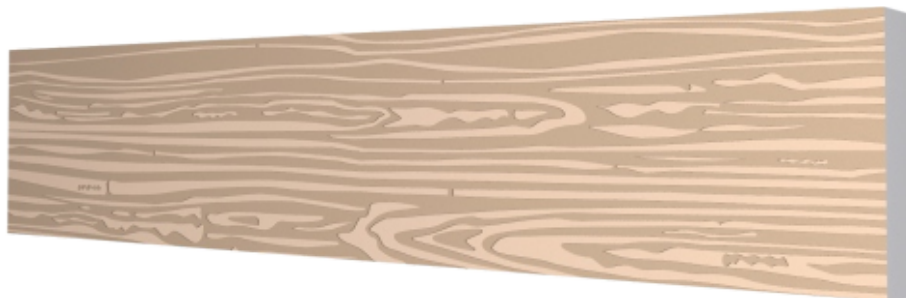

ADNZ-01



ADNZ-02



ADNZ-03



ADNZ-04



ADNZ-05



ADNZ-06



ADNZ-07



ADNZ-08

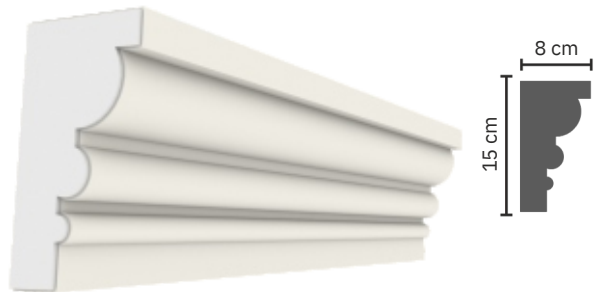



DENİZLİK

ADNZ-09



AA DD NN ZZ -- 11 00



ADNZ-11

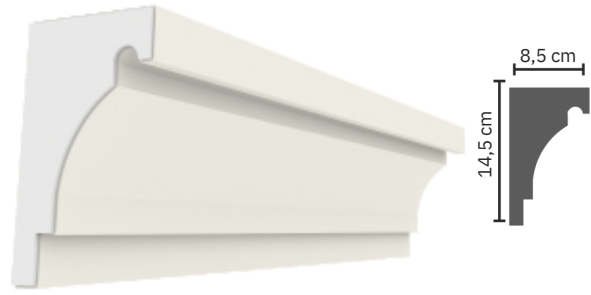

ADNZ-12



AA DD NN ZZ -- 11



AA DD NN ZZ -- 11



AA DD NN ZZ -- 11

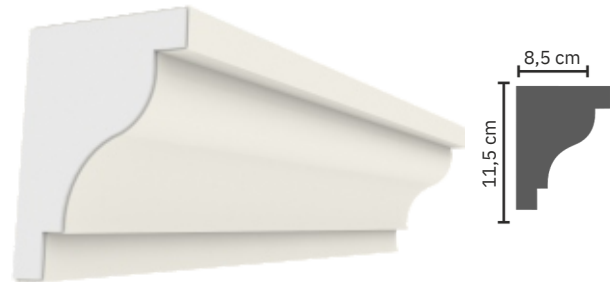

AA DD NN ZZ -- 11

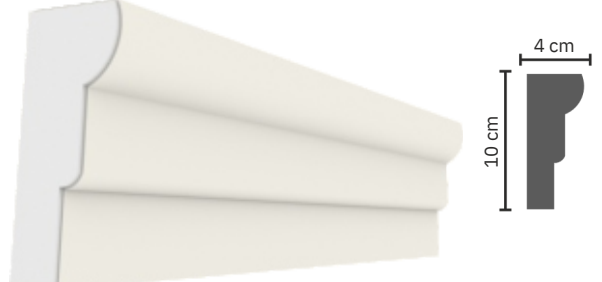

ATAÇ-01



ATAÇ-02



ATAÇ-03

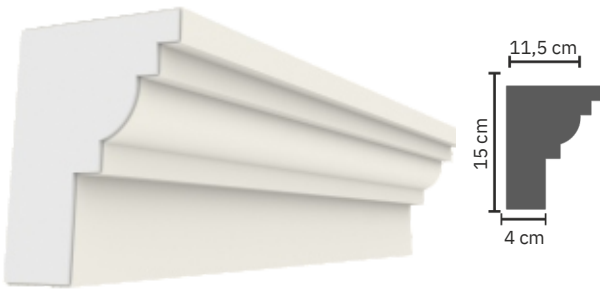

ATAÇ-04

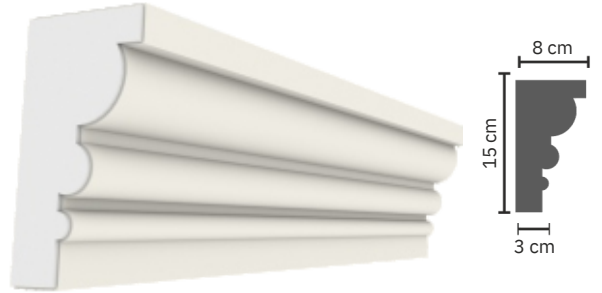

ATAÇ-05

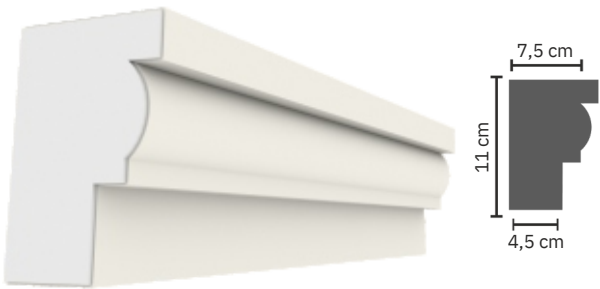

ATAÇ-06



ATAÇ-07

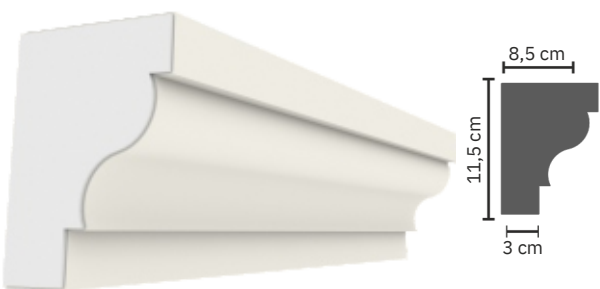

ATAÇ-08

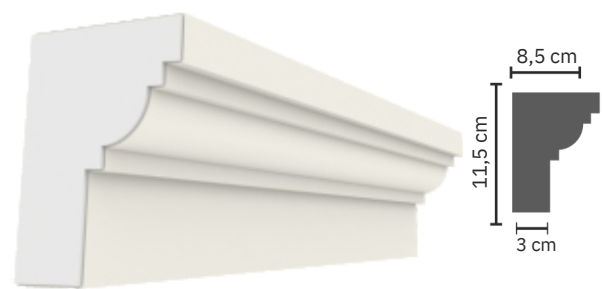

ATAÇ-0119

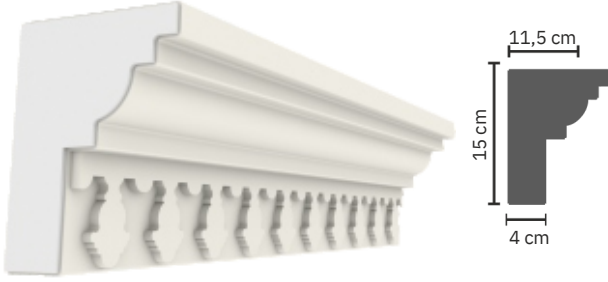

ATAÇ-0120



ATAÇ-0131



ATAÇ-0142

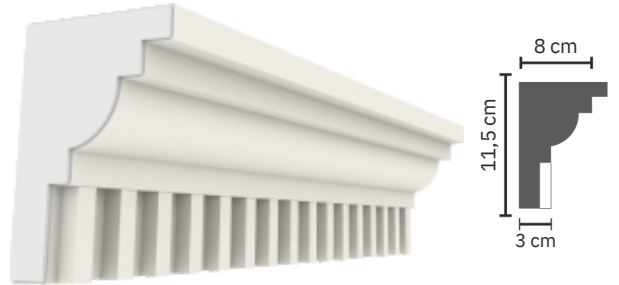

ATAÇ-0153

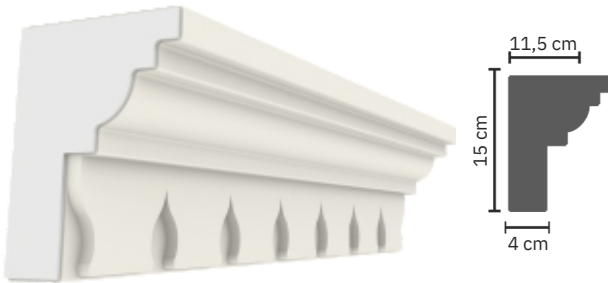

ATAÇ-0164

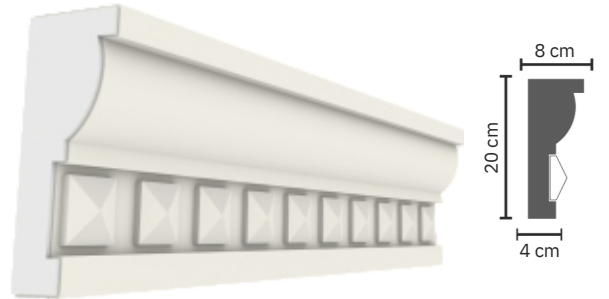

ATAÇ-0175

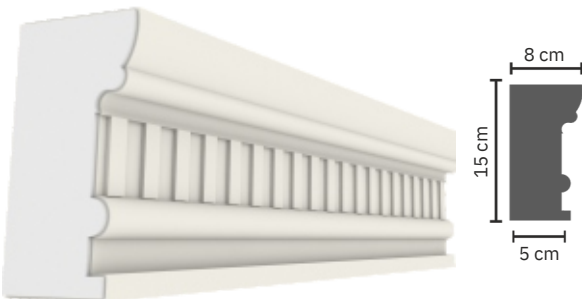

ATAÇ-0186





ABK-01

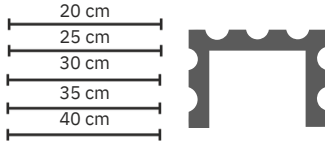

ABK-02

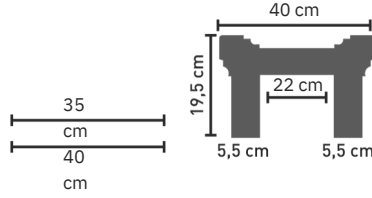

ABK-03

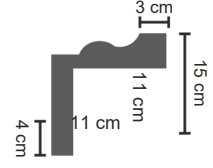
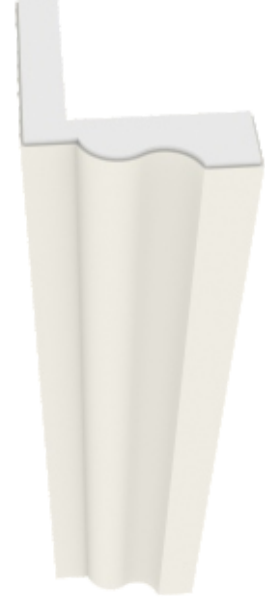



KÖŐE ELEMANLARI

AKE-01



AKE-02



AKE-03



AKE-04

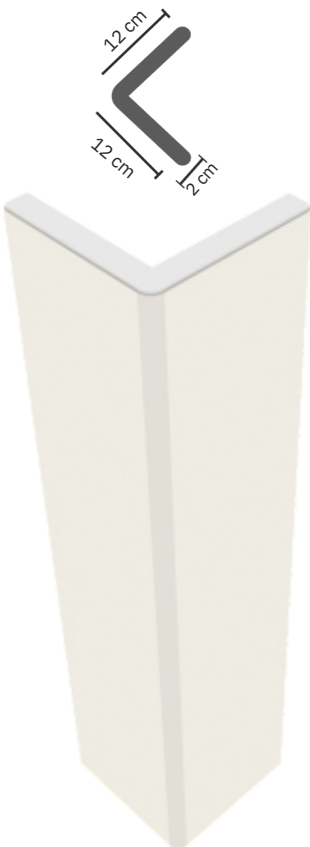

AKE-05



AKE-06

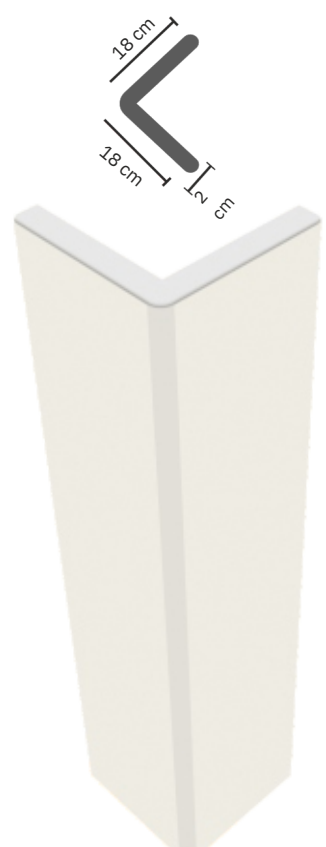



HARPUŐTALAR / CAPSTONES

AHP-01



17 x 25 cm

AHP-02



25 x 26 cm

MANTOLAMA FUGASI / SHEATHING FUGA

AMF-01

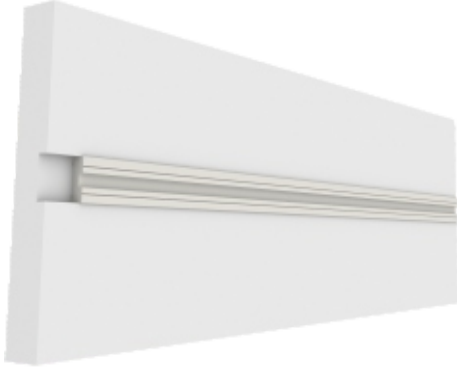

MANTOLAMA SÖVESİ / SHEATHING JAMP

AMFSV-01

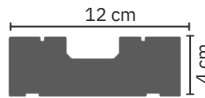
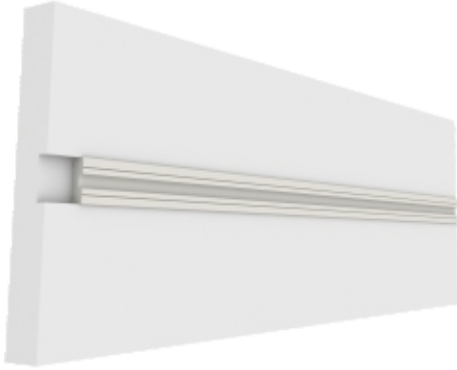

AMFSV-02

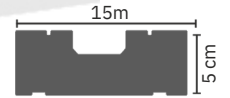
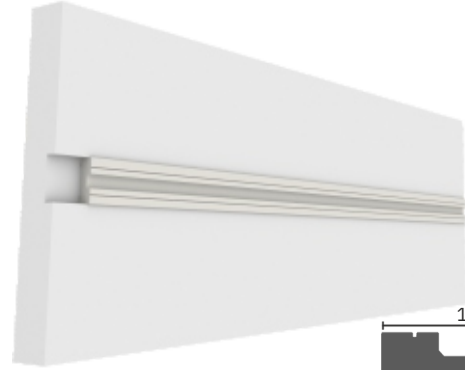



APY-01

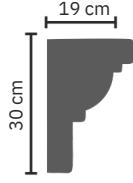

APY-02

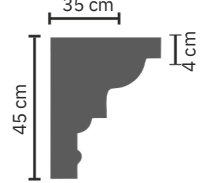

APY-03

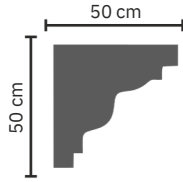
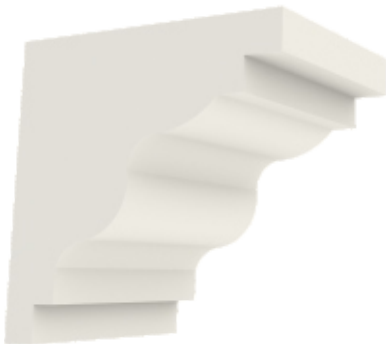

APY-04

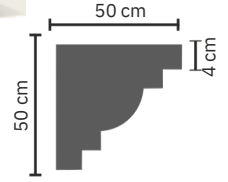

APY-05

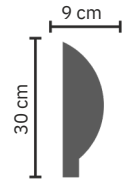

APY-06

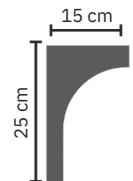

APY-07



APY-08

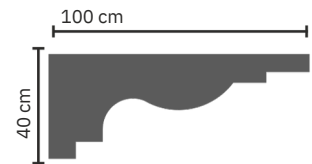
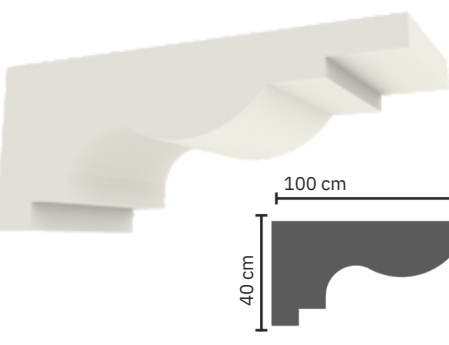

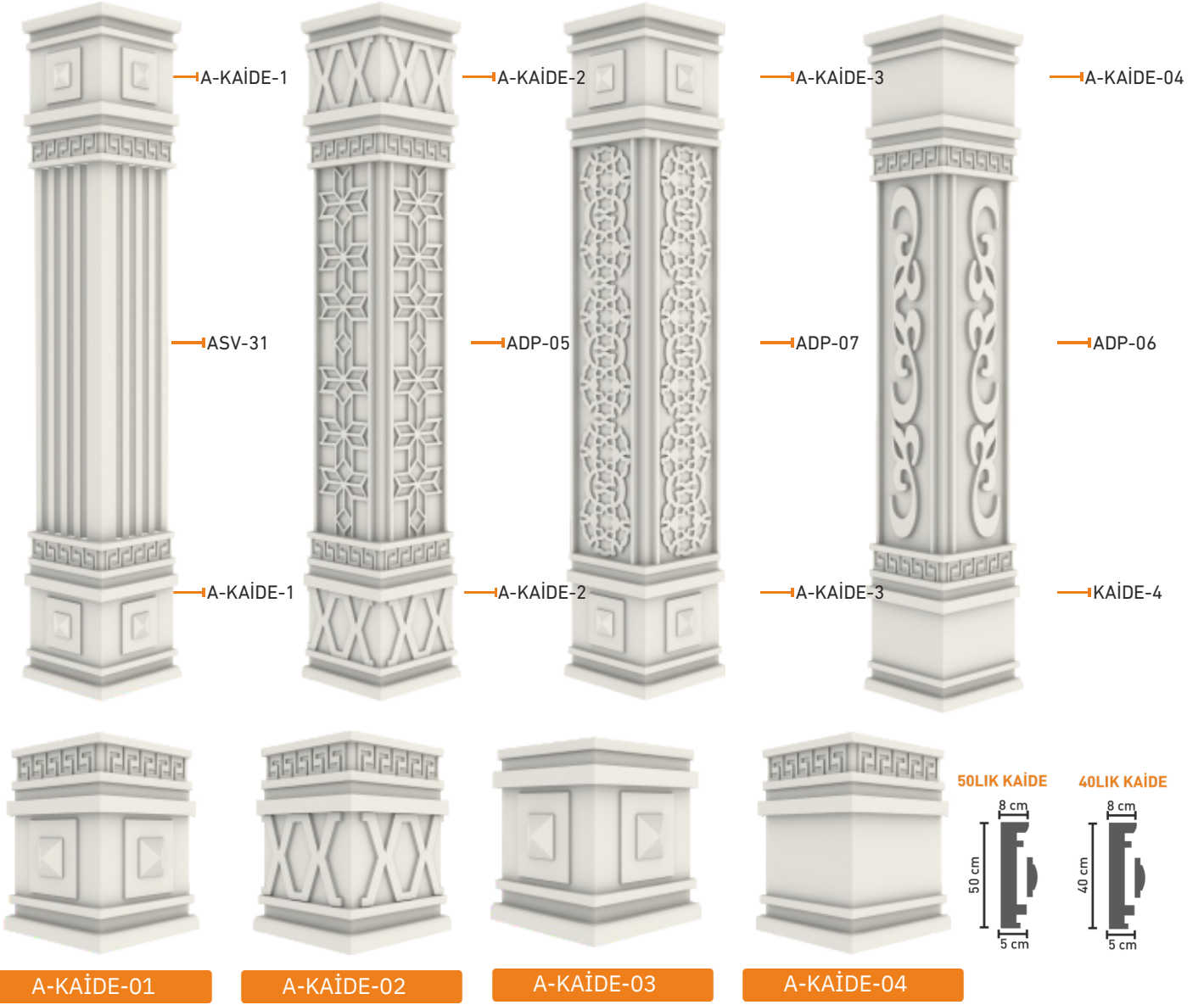



A B C
5cm x 55cm x 200cm

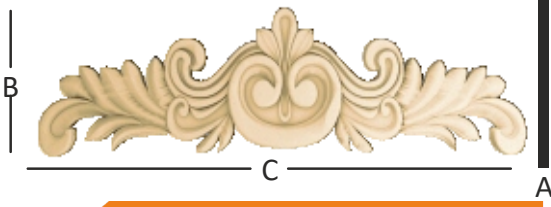

ADT - 01 DESENLİ TAÇ

A B C
5cm x 55cm x 200cm

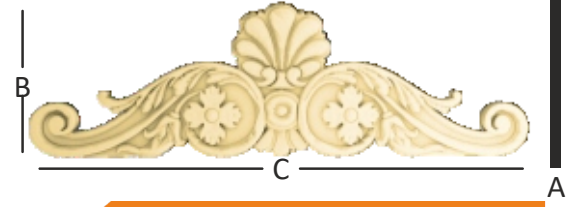

ADT - 02 DESENLİ TAÇ

A B C
6cm x 70cm x 200cm

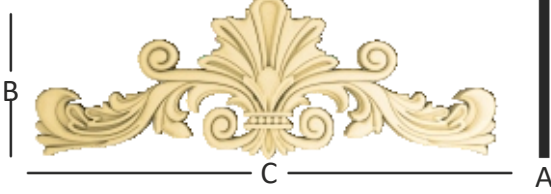

ADT - 03 DESENLİ TAÇ

A B C
10cm x 60cm x 200cm

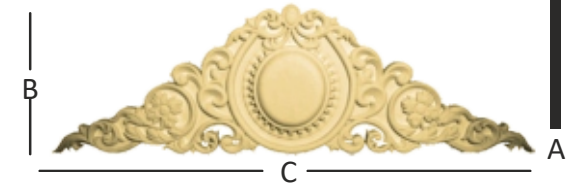

ADT-04 DESENLİ TAÇ

A B C
6cm x 100cm x 200cm

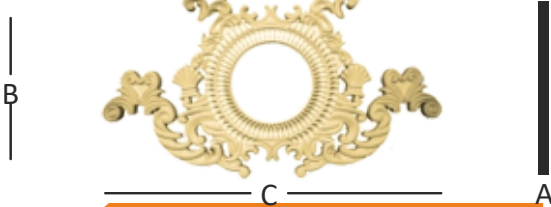

ADT - 05 DESENLİ TAÇ

A B C
5cm x 22cm x 200cm

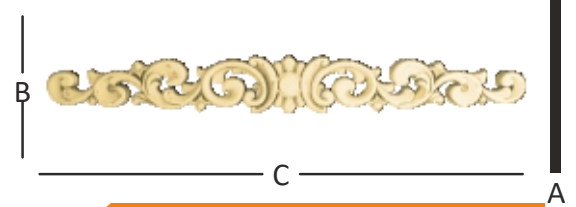

ADT - 06 DESENLİ TAÇ



A B C
15cm x 60cm x 13cm

AP- 01 DEKORATİF PAYANDA



A B C
15cm x 75cm x 11cm

AP- 02 DEKORATİF PAYANDA



A B C
20cm x 40cm x 15cm

AP- 03 DEKORATİF PAYANDA





AKLN-01



AKLN-02

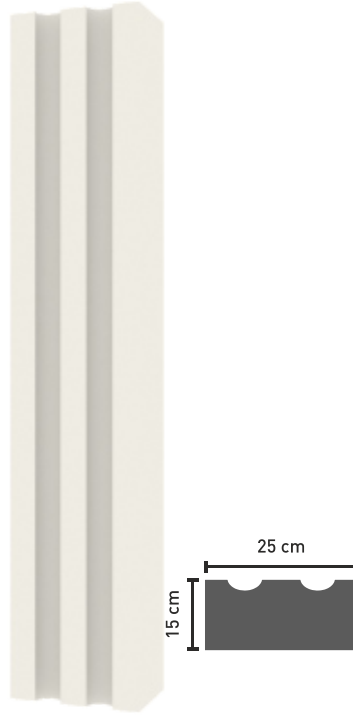

AKLN-03

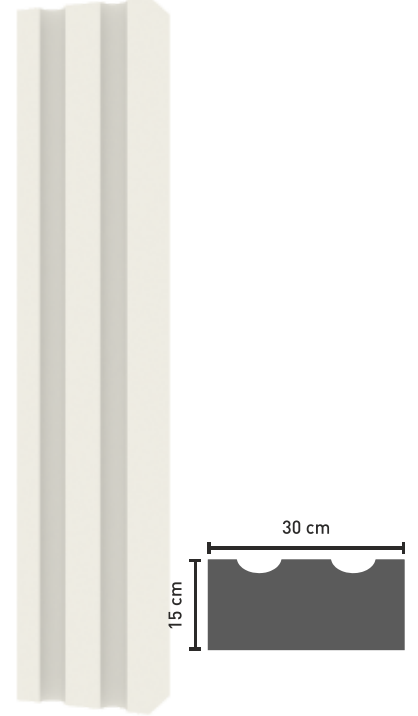

AKLN-04



AKLN-05



AKLN-06

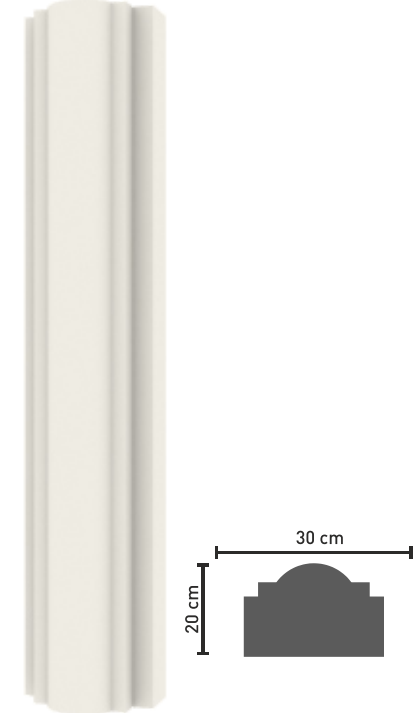



ADÜ-01



50 x 100 cm

ADÜ-02



50 x 50 cm

ADÜ-03



30 x 30 cm



30 x 30 cm

ADÜ-05



50 x 50 cm

ADÜ-06



50 x 50 cm

ADÜ-09



30 x 30 cm

ADÜ-10

ABC....

ÖZEL İSİMLER:
İstenilenEbattaÜretilmektedir

ADÜ-11



50 x 50 cm

ADÜ-13



50 x 100 cm

ADÜ-14



30 x 60 cm

ADÜ-16



50 x 50 cm

ADÜ-18



33 x 35 cm

ADÜ-19



43 x 46 cm

ADÜ-21



30 x 50 cm

ADÜ-24



50 x 50 cm



ADÜ-37

ADÜ-38



50 x 50 cm



50 x 50 cm



100 x 30 cm



100 x 30 cm

ADÜ-39

ADÜ-40

ADÜ-41

ADÜ-42



100 x 30 cm



100 x 30 cm



100 x 30 cm



100 x 30 cm

ADÜ-43

ADÜ-44

ADÜ-45

ADÜ-46



50 x 50 cm
100 x 100 cm



50 x 50 cm
100 x 100 cm



50 x 50 cm
100 x 100 cm



50 x 50 cm
100 x 100 cm





ADÜ-26



50 x 50 cm

ADÜ-27



50 x 50 cm

ADÜ-28



50 x 50 cm

ADÜ-29

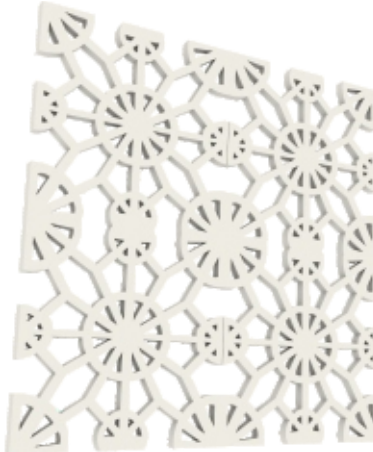

50 x 50 cm

ADÜ-30



ADÜ-33



50 x 50 cm

ADÜ-31

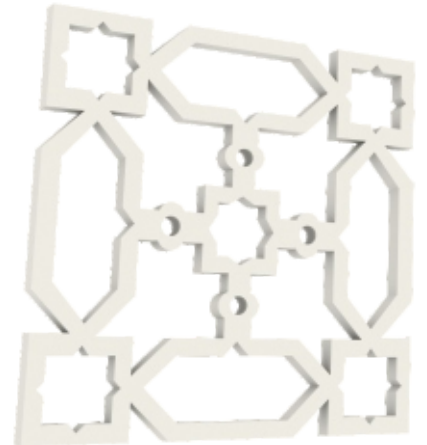

ADÜ-34

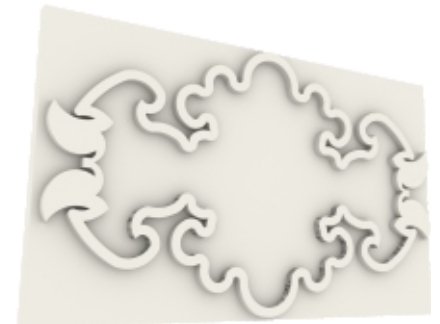

50 x 100 cm

ADÜ-32

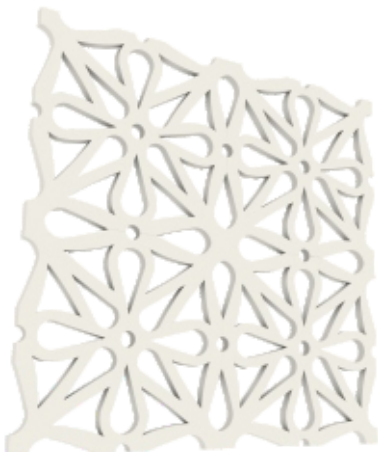

50 x 50 cm

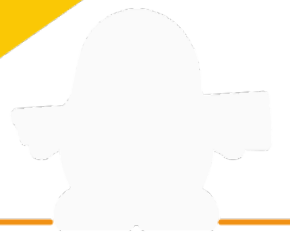

AKT-01

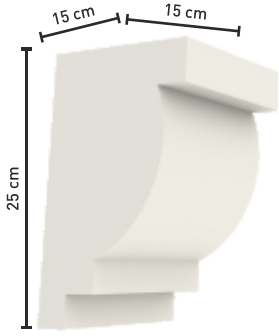

AKT-02

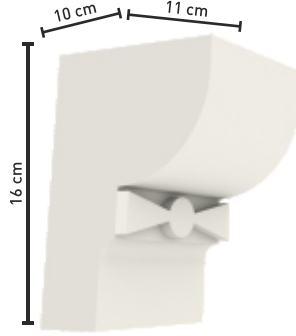

AKT-03

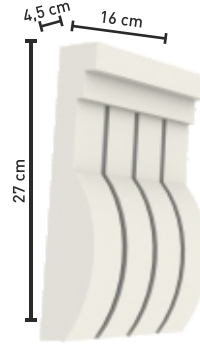

AKT-04

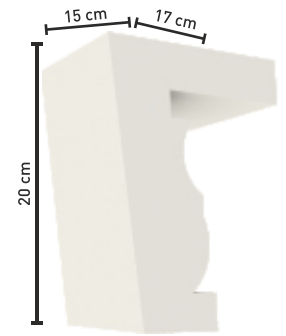

AKT-05

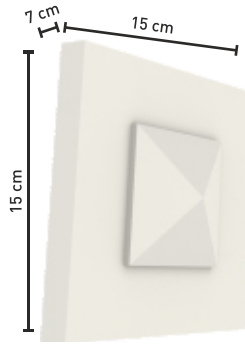

AKT-06

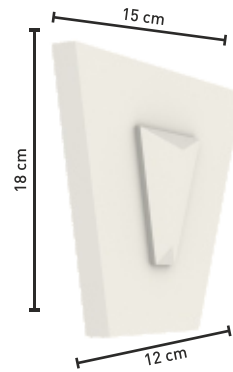

APLİK-01

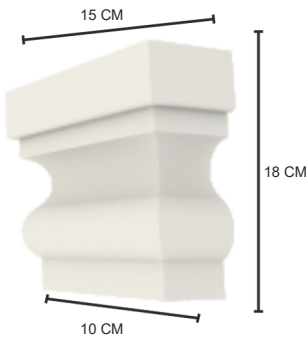

APLİK-02

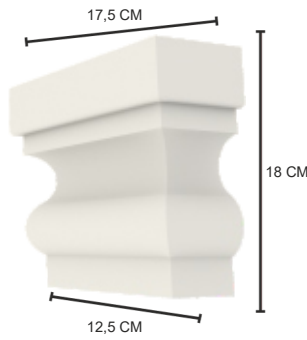

APLİK-03

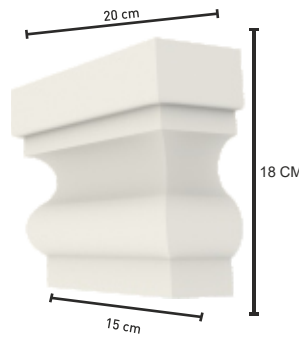

APLİK-04

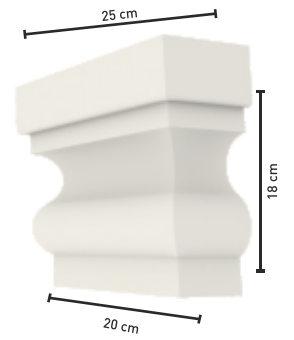

YILDIZ-01



2 cm x 8 cm x 8cm

YILDIZ-02



2 cm x 10 cm x 10cm

YILDIZ-03



4 cm x 15 cm x 15 cm

YILDIZ-04



4 cm x 20 cm x 20 cm

YILDIZ-05



4 cm x 25 cm x 25 cm





EPS DESENLİ KARTONPİYER / FIGURED PAPIER MACHES

ADSK-01



106 mt

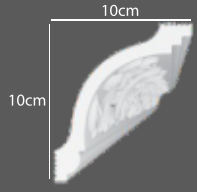

ADSK-02



72 mt

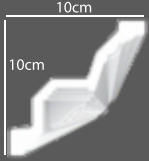

ADSK-03



106 mt

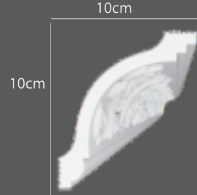

ADSK-04



106 mt

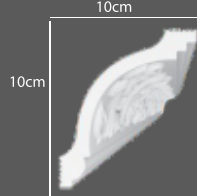

ADSK-05



106 mt

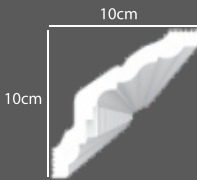

ADSK-06



100 mt

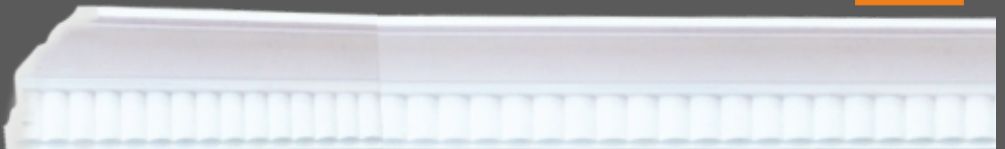
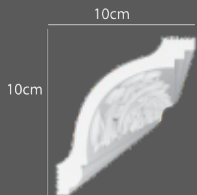



AK-01

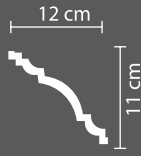

AK-06

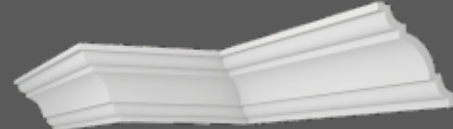

AK-02

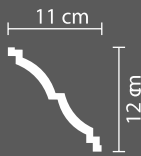
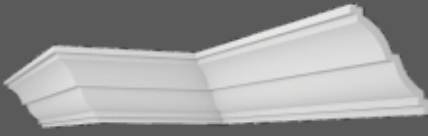

AK-07

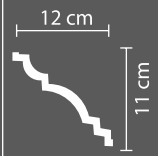
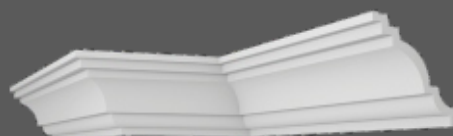

AK-03

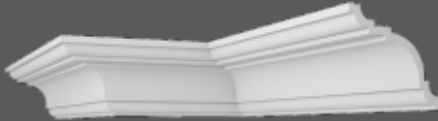

AK-08

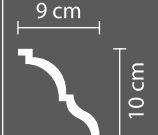

AK-04

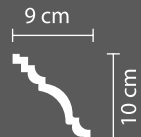

AK-09

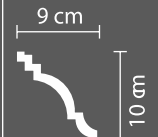

AK-05



AK-10

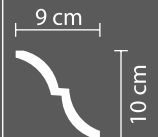
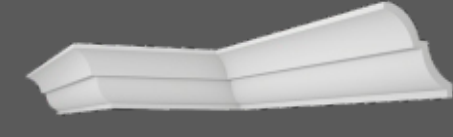



AK-11

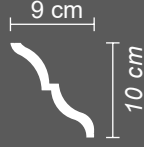
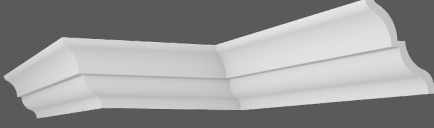

AK-16

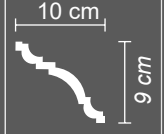
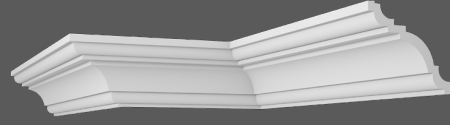

AK-12

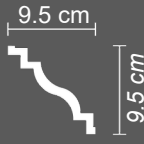
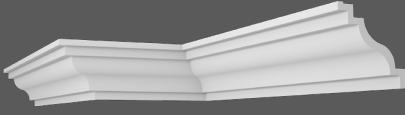

AK-17

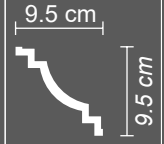
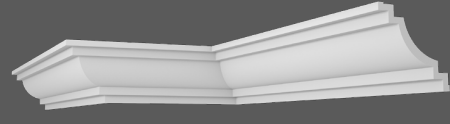

AK-13

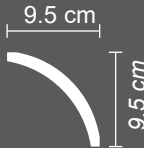
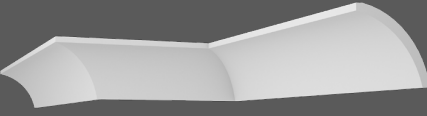

AK-18

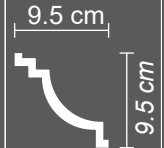
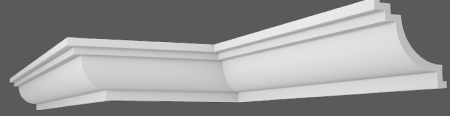

AK-14

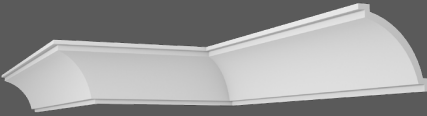

AK-19

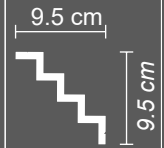
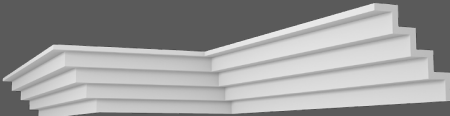

AK-15

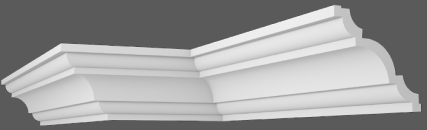

AK-20

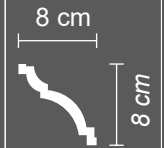
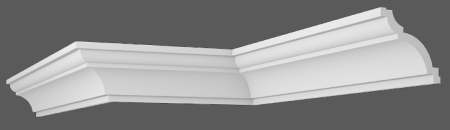



GÖBEK / ROSETTES

DÜZ



AGS-751 R: 47 cm

KOLİ ADETİ 32



SARAY



AGS-743 R: 47 cm

KOLİ ADETİ 34



BAŐAK



AGS-752 R: 47 cm

KOLİ ADETİ 32



AT KUYRUĐU



AGS-755 R: 47 cm

KOLİ ADETİ 30

